

AquaDam[®]

User's Guide ~ 2004

(Includes Material Specifications)



“Water Controlling Water”[™]

**LOW-IMPACT, ENVIRONMENTALLY FRIENDLY WATER FILLED
COFFERDAMS FOR STREAM DIVERSIONS, FLOOD CONTROL,
HAZ-MAT CONTAINMENT, AND DEWATERING STRUCTURES.**

AquaDams[®] are water filled barriers that can be used as dams or cofferdams for stream diversions and dewatering boat ramps, boat docks, and pond liners for repairs. Also excellent for flood protection, they are more effective than sandbags and other water control devices.

.....5ei U8 Ua 'bW
P.O. Box 144 / 121 Main St.
Scotia, CA 95565
(800) 682-9283
www.AquaDam.net
email: matthew@aquadam.net

Table of Contents:

INTRODUCTION	3
ABOUT THE COMPANY	3
PATENTS	3
CONCEPT	4
APPLICATIONS	6
AQUADAM® HEIGHT SELECTION AND SIZE CRITERIA	7
TABLE 1: STANDARD AQUADAM® SIZES AND RECOMMENDED USE	7
Water Depth:	7
Water Velocity:	8
Installation Site:	8
Weather / Spring Run-off:	8
Other Site Criteria:	8
Width of the River:	8
Rough River Bed:	8
INSTALLATION	9
SMALL AQUADAMS® (1'- 4' high)	9
LARGE AQUADAMS® (6' – 16' high)	10
Table 2: RECOMMENDED MANPOWER REQ. FOR MOVING WATER SCENARIOS	10
AquaDam® Installation Procedures	11
Step 1-Transport:	11
Step 2-Starting Point:	12
Step 3-Preparing the AquaDam® for Inflation:	13
Step 4-Moving Rocks and Debris:	13
Step 5-Restraining Ropes:	14
Large AquaDams®	14
Standing Water Applications:	14
Step 6-Determine Height & Elevation:	14
Step 7-Inflating the AquaDam®:	15
Manning the Ropes:	16
Lateral Movement:	17
How Lateral Movement Occurs:	17
CONNECTING AQUADAM® SECTIONS USING COUPLING COLLARS:	18
Figure 7: CONNECTING AQUADAMS® USING COUPLING COLLARS	21
MAINTENANCE PROCEDURES	22
AQUADAM® REMOVAL USING REROLLING BRACKETS	23
LARGE AQUADAM® REMOVAL	24
SAFETY	25
Emergency Removal:	25
Obstacles & Debris:	25
Cold Weather:	25
Walking on the AquaDam®	25
AquaDam Material Specifications	26

INTRODUCTION

AquaDam Inc® manufactures AquaDams®, a low-impact alternative to temporary earthen fill cofferdams (barriers). The Clean Water Act demands the use of alternatives to fill discharges to achieve Best Management Practices. On site mitigation is mandatory. Alternative protective devices, such as water filled cofferdams, are the ideal tools for water management programs that protect the aquatic environment. The US Army Corps of Engineers has and is presently approving the use of AquaDams® as a viable, environmentally acceptable method of diverting or containing water.

The following is an overview of Aqua Dam Inc; the various applications of AquaDams®; site and size requirements; equipment and manpower requirements; installation techniques; safety, maintenance, and removal.

ABOUT THE COMPANY

AquaDam Inc was incorporated in 2003, after 20 years of using the idea created in the late 1980's to offer a new concept for managing water diversions, dewatering, flood control barriers, levee toppings, and water storage by using AquaDam Inc® offers installation services and free consulting services regarding the installation and implementation of a water filled cofferdam. The most important features of AquaDams® are the ease and speed at which they can be installed (especially in emergency situations). They consist almost entirely of onsite water, and are reusable.

PATENTS

Aqua Dam Inc uses patents on the design and utilization of multiple chambered AquaDams® that use water and air as the inflation media, and the technique used in connecting multiple AquaDams® together to achieve any necessary length.

US Patent No. 5059065

US Patent No. 5125767

US Patent No. 6481928

Several other patents are currently pending.

CONCEPT

AquaDams® are portable dams filled with onsite water that can be installed wherever needed to cofferdam, contain, or divert the flow of water. AquaDams® consist of two basic parts: an outer or "master tube" (C) made of a heavy duty geotextile woven polypropylene which holds the two inner tubes (A & B) in contact when filled with water. The outer and inner tubes combine to form an AquaDam® as shown in Figure 1, a cut away section illustrating the relationship between the inner and outer tubes of a typical filled AquaDam®.

Figure 1: A TYPICAL FILLED AQUADAM®

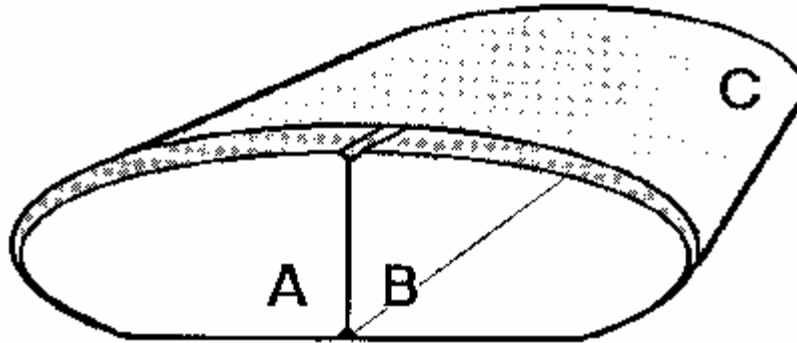

Figure 1. A cross section of a typical AquaDam®, illustrating the relationship between the two inner tubes which contain the water and the "master" tube that keeps the inner tubes parallel and in contact with each other.

A and **B** illustrates the two inner tubes inflated with water.

C is the outer or "master" tube made of very tough polypropylene woven geotextile fabric which confines the water filled inner tubes, making the AquaDam® a solid wall of water. These two confined columns of water provide the mass, weight, and pressure that gives the AquaDam® its stability.

To install an AquaDam®, onsite water is pumped into the two inner tubes during the installation process. The durable woven outer tube confines the water-inflated inner tubes. The counter friction / hydraulic pressure between the inner tube and the outer tube, along with the mass and weight of the water, creates pressure and stabilizes the AquaDam® when lateral water pressure is exerted against it. Due to the inherent flexibility of the materials used to confine the water, AquaDams® will conform to most surfaces, providing an excellent seal and keeping water seepage to a minimum.

AquaDams® come in a variety of sizes, ranging from 1 to 16 feet in height when inflated. AquaDams® come in standard lengths of 50 or 100 feet, and are available for immediate shipment. Any length can be fabricated. Shorter, longer, or irregular lengths are available with notice. Using attachment collars, two or more AquaDams® can be joined together to form a continuous cofferdam of any necessary length. AquaDams® are joined together by a patented coupling collar connection (standard with each AquaDam®). Large and small AquaDams® can be used in conjunction with each other. The possible configurations are almost endless. They can be used in a straight line, to form an arc, or to encircle a building. AquaDams® can also be connected at angles to each other, as may be required by the job requirements.

AquaDams® are usually assembled at the factory and shipped rolled and ready for use at the job site. However, it is not unusual to assemble larger AquaDams® on site. A typical AquaDam® consists of the "master tube" and a pair of inner tubes rolled up on a wooden or metal core as shown in Figure 2. In many instances, the core also plays an important part in the installation, rerolling for future use, and transportation of AquaDams®.

Figure 2:

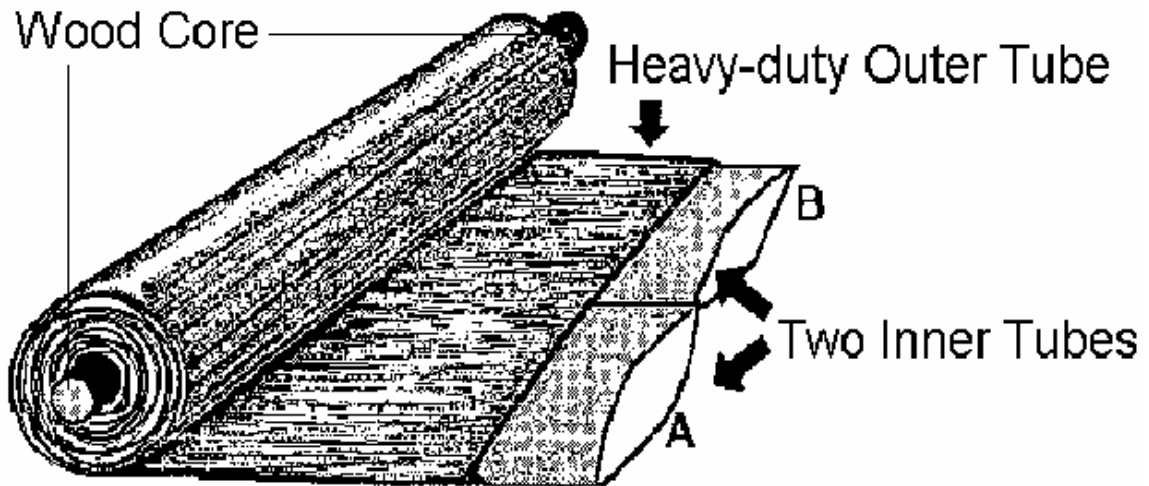

Figure 2. A typical factory assembled AquaDam® prior to inflation, showing the inner and outer tubes rolled up around the core. The AquaDams® tubes (A & B) are left open for filling purposes. This end will be elevated up the stream bank (the starting point) which has to be higher than the height of the AquaDam® when fully inflated. The other end is sealed and has an attached coupling collar used for joining a second AquaDam®.

APPLICATIONS

AquaDams® can be used in a wide range of applications. Listed below are some of the more common applications of AquaDams®:

- | | |
|---|--|
| <ul style="list-style-type: none">• Cofferdams for dewatering construction sites• Water diversion in rivers and wetlands• Water containment• Flood control• Erosion control through diversion or containment of flowing water• Water storage• Boat ramp dewatering• Pond liner repair dewatering• Bridge pier repair• Pipeline crossings | <ul style="list-style-type: none">• Water intake structures for municipalities• Water discharge structures• Fish habitat improvement• Silt containment, sediment collection, or settling ponds• Levees, levee toppings• Hazardous material or chemical spills (containment)• Temporary foot causeway through environmentally sensitive areas• Wetlands management |
|---|--|

The old ways of earthen fill discharges and expensive sheet piling have been the historic ways of working in waterways. These methods are environmentally detrimental, time consuming, and expensive because of their reliance on heavy equipment.

Water filled cofferdams make the ideal water control structure for construction sites. Onsite water is pumped into an AquaDam®, which unrolls due to the water pressure inside it and can be installed in hours in most applications, without causing damage to the aquatic environment. Complete dewatering of the work site can be achieved to form and pour concrete, remove sediments, and install geotextiles.

When used for flood control and augmenting levees, for example, AquaDams® are much more effective than sandbags. They can be installed far quicker, at a fraction of the cost, without all the foot traffic associated with labor-intensive sandbagging, and best of all AquaDams® are reusable.

The amount of water that can be stored in a standard 4 foot AquaDam®, with a width of 10 feet and a length of 100 feet (filled to capacity), is about 25,000 gallons. AquaDams® are durable, long lasting, and with proper installation and removal can be stored and used again and again. Should an inner tube develop a leak, patching tape is available. If necessary, replacement tubes are available from Aqua Dam Inc. AquaDams® are relatively easy to install, requiring only a couple of portable pumps, an onsite water supply, and two or more laborers depending on the size of the AquaDam®.

AQUADAM® HEIGHT SELECTION AND SIZE CRITERIA

AquaDam® height selection is determined by work site conditions, the water depth to be contained or diverted, and to a lesser degree, stream bed slope and water velocity. Maximum projected changes in water depth are very important during the life of the diversion project. Table 1 lists sizes of AquaDams® and their recommended water depth usage. Customized dams of any length can be ordered.

**TABLE 1: STANDARD AQUADAM®
SIZES AND RECOMMENDED USE**

INFLATED HEIGHT (FEET)	INFLATED WIDTH (FEET)	CONTROLLED WATER DEPTH (INCHES)
1	2	9
1.5	3	14
2	4	18
3	7	30
4	-	38
5	1%	44
6	1'	56
8	1+	7(
10	23	-\$
12	27	10(
1*	3'	1' &

This chart represents maximum water depths to be controlled on flat surfaces. The slope and topography of the streambed needs to be accounted for as well as water depths.

Water Depth:

The height of water to be contained by the AquaDam® is the most important factor when selecting the proper size. A good rule of thumb for determining the water height after diversion is as follows:

Add:

- 1.) the maximum water depth along the installation site,
- 2.) the average depth of water at the installation site,
- 3.) and the difference in elevation (water levels) between the installation and diverted water sites.

These three numbers equal the height of water that will be found at the installation site after the AquaDams® have been installed and water is flowing through the diversion channel.

The importance of determining the correct projected maximum water depths after installation and diversion of the stream cannot be taken too lightly. Too small of an AquaDam® will fail. **The depth of water to be retained by an AquaDam® is often underestimated, resulting in an AquaDam® that is too small for the project. This results in delays, increased costs and potentially unsafe work conditions!**

Water Velocity:

When an AquaDam® is used to dam or divert flowing water, water velocity is a concern. During installation, the AquaDam® is being filled with water, causing it to unroll across the stream channel. This causes water flow to back up and increase in water depth. The water velocity around the end of the AquaDam® is increased. Depending on the firmness of the river bed, some undercutting might occur around the end of the AquaDam® as it is being installed. This results in an increase in the depth of water to be retained and should be factored into the analysis. Velocity of current is also a factor. The water head will build up on the upstream side and water on the downstream side flows away before the completion of the installation.

Installation Site:

AquaDams® can be installed on top of most types of soils or fluvial materials, including: flat lying bed rock, mud, sand, gravel, small rocks, and vegetation. Select a site that is flat, and void of: wire, rebar, sharp objects, garbage, glass or dead vegetation containing tree branches, or other rip-rap. The slope of the riverbed should also be relatively flat or inclined in the direction of the upstream or contained water. Make sure to check the installation course for holes, obstructions or washed out areas that may cause problems during installation.

Weather / Spring Run-off:

Local wet seasons and thunderstorms affect water levels in rivers, lakes, and wetlands and are important to understand during your construction Project. Projects that have flexible construction dates should be coordinated with favorable weather conditions that avoid high water levels. Water depth being retained by the AquaDam® should never exceed the recommended maximum water depth during the life of the project, not just the day you install it.

Other Site Criteria:

All of the previous factors are important considerations once the site has been selected. The following are additional factors that may influence the site selection:

Width of the River:

A location on a wide, shallow river is easier to cofferdam than a narrow river channel. Wide rivers will allow a diversion with only minor increases in water depth. A narrow river will quickly increase in water depth. The larger and wider the diversion channel, the less water depth will increase.





Rough River Bed:

An extremely rugged alpine river bed (such as the Eagle River) with large angular boulders within the stream bed is a difficult area, since a good tight seal can only be accomplished through the removal of said boulders by hand or heavy equipment. In the case of the Eagle River, the boulders were scraped into a line, and the AquaDam® was installed directly upstream so that the boulders would help support it. Using four ropes was also important in the installation.

INSTALLATION

SMALL AQUADAMS® (1'- 4' high)

Equipment List:

-  We recommend that you use at least two portable gasoline water 2"-3" discharge pumps or one gasoline discharge pump switched from fill tube to fill tube during inflation; any available water supply will work. Anything from fire hydrants to garden hoses is acceptable; it all depends on the speed at which you want to install the AquaDam®. *
-  Two discharge and suction hoses, one each per pump; no fitting is required on the end of the discharge hoses.
-  A roll of duct tape to secure and constrict the size of the fill tubes when coupling AquaDams® together.
-  For safety reasons, each laborer should carry a utility knife.

The Aqua Dam Inc® crew uses 5.5HP Honda-powered 3" Volume Pumps which provide a maximum flow rate of 16,200 GPH. They are available from your local distributor for sale or rental. They can also be ordered from Great Plains Manufacturers and Distributors 1-800-525-9716; using two of these, you can inflate: A 1' high by 100' long AquaDam® in less than 15 minutes; a 2' high by 100' long AquaDam® in 30 minutes; a 3' high by 100' long AquaDam® in under an hour; and a 4' high by 100' long AquaDam® in under an hour and a half.

Manpower:





Two to four laborers are required to install the smaller AquaDams®. Plan out the installation beforehand and discuss it with your work party. The number of AquaDams® to be installed, time constraints, and access to the installation sites may dictate the need for additional help.

Rock removal:

Someone will have to remove rocks by hand from the path of the AquaDam® to assure that a good seal is achieved (see the Lemhi River installation on our website). The laborers installing the AquaDam® are already committed, and cannot be the rock picking crew. Please see the Installation Section of our web site. Rocks should be picked out from directly in front of the AquaDam® as it is being installed. The rocks can be stacked on the downstream side of the AquaDam® to provide additional support (see the Williams Transco Gas Pipeline installation project in Williamsport, PA. on our website).

LARGE AQUADAMS® (6' – 16' high)

Equipment List:

-  At least two discharge pumps are required; using larger or more numerous pumps will inflate the AquaDam® faster; the fill tubes can be opened to accommodate any size discharge hose.
-  One discharge and suction hose per pump; discharge hoses do not require fittings.
-  A roll of duct tape for securing the fill tubes.
-  For safety reasons, each laborer should have a utility knife.
-  In moving water, restraining ropes need to be used to assist the installation; at the very least, each 100 foot AquaDam® that is installed requires 250 feet of ½ inch rope. A four rope setup is strongly recommended on the installation of AquaDams® 6' high or larger in fast-moving rivers and streams (please see the Eagle River Crossing under the Installation section of our web site).

Manpower (for installation in non-moving water):

Three to five laborers are needed to install the larger AquaDams® in non-moving water. Ropes are usually not needed to restrain the AquaDam® from unrolling during the installation process, but can be used to pull the AquaDam® around if water depths are too great for a laborer to stand. Non-moving water conditions require the fewest number of laborers.

Manpower (for installation in moving water):

Five to seven laborers are needed to install the larger AquaDams®; the exact number of laborers is related to the size and number of AquaDams® to be installed, terrain, water velocity, water depths, and time constraints. Table 2 better describes the manpower needs during a typical installation of AquaDams® 6' or more in height in moving water.

Table 2: RECOMMENDED MANPOWER REQUIREMENTS DURING INSTALLATION IN MOVING WATER

AQUADAM® SIZE	ROPE ASSISTED INSTALLATION	NUMBER OF LABORERS IN WATER	NUMBER OF LABORERS ON PUMPS
1-3 FEET	NO	2-4	0-1
4 FEET	NO	3-5	1
4 FEET	YES-2	2-4	1
6 FEET	YES-3	2-3	1
8 FEET	YES-4	2-3	1

Table 2 (cont.):

Manpower requirements are based on a particular size of AquaDam® in moving water. The chart also provides the number of ropes commonly used with a specific size AquaDam®. Note that 4, 6, and 8 foot structures are commonly installed with the aid of ropes to prevent them from unrolling prematurely. Only in standing water would rope assisted installations not be used on larger size AquaDams®.

Strong water velocities or currents require more manpower to insure proper installation, and to secure the safety of those installing the AquaDam®. The above list does not address personnel that might be operating heavy equipment, such as an excavator. An AquaDam Inc® supervisor who oversees the installation procedure is also recommended.

In most installations, very little site preparation work is required, but to obtain a good seal, rock picking is a must. The area should also be policed for objects that might puncture the AquaDam® during installation.

This Guide assumes that all Federal, State, County, and City Permits have been obtained from the appropriate government authority. Aqua Dam Inc also recommends that the buyer (Prime Contractor, Company Supervisor, etc.) have an understanding of the necessary permits and what can or cannot be done within the river bed (lake) should the use of heavy equipment be necessary.

AquaDam® Installation Procedures

Installation can be broken down into two categories: Moving water (rivers and streams) and nonmoving water (lake shores).

Step 1-Transport:

Transport the AquaDam® to the installation starting point. Smaller AquaDams® can be easily moved into position by hand.



Carrying straps are provided on larger AquaDams®. Just hook or tie the straps to a piece of heavy equipment for transportation. Unpack the AquaDam® by carefully removing the protective wrap from the outside after cutting the packing ropes and carrying straps with a knife.



Step 2-Starting Point:

The end of the AquaDam® will have long fill tubes to start with (usually 2-6 foot long). These are for connecting one AquaDam® to another using a collar. They are not the start of the AquaDam®. The AquaDam® starts at the outside (usually black or white) master tube that confines the two inside fill tubes (see Figure 1). Position the end of the outer tube up the bank at least as high as the AquaDam® will be when fully inflated (i.e., a 3 foot high AquaDam® would have at least 4 feet in elevation up the bank. The bank slope will have to be calculated in, and the end will have to be higher than the water level inside the AquaDam® after inflation. The AquaDam® will only achieve a height of 3+ feet at the lowest point along its path.).

If the bank is not steep enough to achieve the necessary starting height, a small amount of fill material can be placed at the waters edge to create a false bank or berm. This is the least expensive way to make a good starting point.



Step 3-Preparing the AquaDam® for Inflation:

Insert a discharge hose into each inside fill tube. Excess fill tubes can be cut off if not desired for future use. Wrap duct tape or tie packing rope tightly around the fill tubes to keep the discharge hose from slipping out. The corners at the end of the AquaDam® can be tied to a tree or rock to prevent it from slipping down the bank slope. For smaller dams (3 feet and under), laborers are needed to stand in back of the AquaDam® roll at the foot of the slope along the waters edge. The pumping begins by pumping into both inside tubes at the same rate. The rolled portion of the AquaDam® will try to unroll, and will push up against the laborers' legs. The laborers' will wait for the water level to rise and build pressure inside the AquaDam®. When the height of the AquaDam® is great enough, the laborers should take a step back. Then they must wait until the height builds up again before taking another step backwards. All laborers must step backwards in unison and cooperate so that a foot does not get caught while unrolling it®. Water levels inside the AquaDam® must be kept at a level higher than the upstream water side of the AquaDam® (see the Pacific Gas and Electric and other installations on our website). This water depth will increase as the unrolling AquaDam® begins to constrict (cut off) the stream flow.

Step 4-Moving Rocks and Debris:

When installing an AquaDam®, you must not only remove rocks from its path to ensure a good seal, you must remove all debris. Sharp, angular objects are often located under the water level, and usually the only way to find them is to walk around in the water until you step on them. Not only will these obstructions cause a greater amount of leakage, there is always the possibility that they may cause damage to the AquaDam®.

**Never take it for granted that your work area is free from debris!
ALWAYS CHECK FIRST!**

THIS IS YOUR ENEMY...



This shopping cart was completely invisible during high tide.

Step 5-Restraining Ropes:

Large AquaDams®

AquaDams® that are four or more feet in height commonly require restraining ropes to restrain the unrolled portion of the AquaDam® during the installation process in live streams. Without these lines or ropes the pressure of the water in the inner tubes would cause the AquaDam® to unroll before the proper inside head pressure is achieved. Preventing this pressure from prematurely unrolling the AquaDam® is very important. The pressure of the water mass inside the AquaDam® has to overpower the pressure of the water on the upstream side (compared to the downstream side). In lake water, the pressure will be the same on both sides of the AquaDam® (until dewatering begins by pumping).



The number of ropes (lines) required by a particular sized AquaDam® is discussed in Table 2 and Figure 3. If ropes are to be used in the installation process, they should be placed under the AquaDam® before water is added. The ropes are attached to the base of the metal posts or trees, then run under the AquaDam®, over the top, and back to the starting point. They should be held in a manner that will allow the rope to be let out as the AquaDam® unrolls across the stream. The rope should be twice as long as the AquaDam® when inflated, plus an extra 50 feet.

Standing Water Applications:

Standing water or lake installations are much simpler than those using AquaDams® or in live streams. The AquaDam® will unroll itself with a minimum number of laborers to assist in the installation. Ropes can be used to turn the AquaDam® in places where it is too deep for laborers to stand. Water pressure from one side of the AquaDam® to the other should stay equal, making it unnecessary to maintain head pressure inside the unit. Laborers just need to guide it in the right direction.

Step 6-Determine Height & Elevation:

The rolled AquaDam® should start at the top of the riverbank or berm. The end of the AquaDam® must be raised higher up the starting bank than the estimated height of the fully inflated AquaDam®. Gravity keeps the water used to fill the AquaDam® from flowing back out the elevated end. (Actually, we recently began offering double closed-ended AquaDams® which do not need to have the end elevated to hold water. However, the start of the AquaDam® must still tie into something like a bank or berm or water would just go around the end.)

Figure 3: LARGE AQUADAM® INSTALLATION ACROSS A FLOWING STREAM

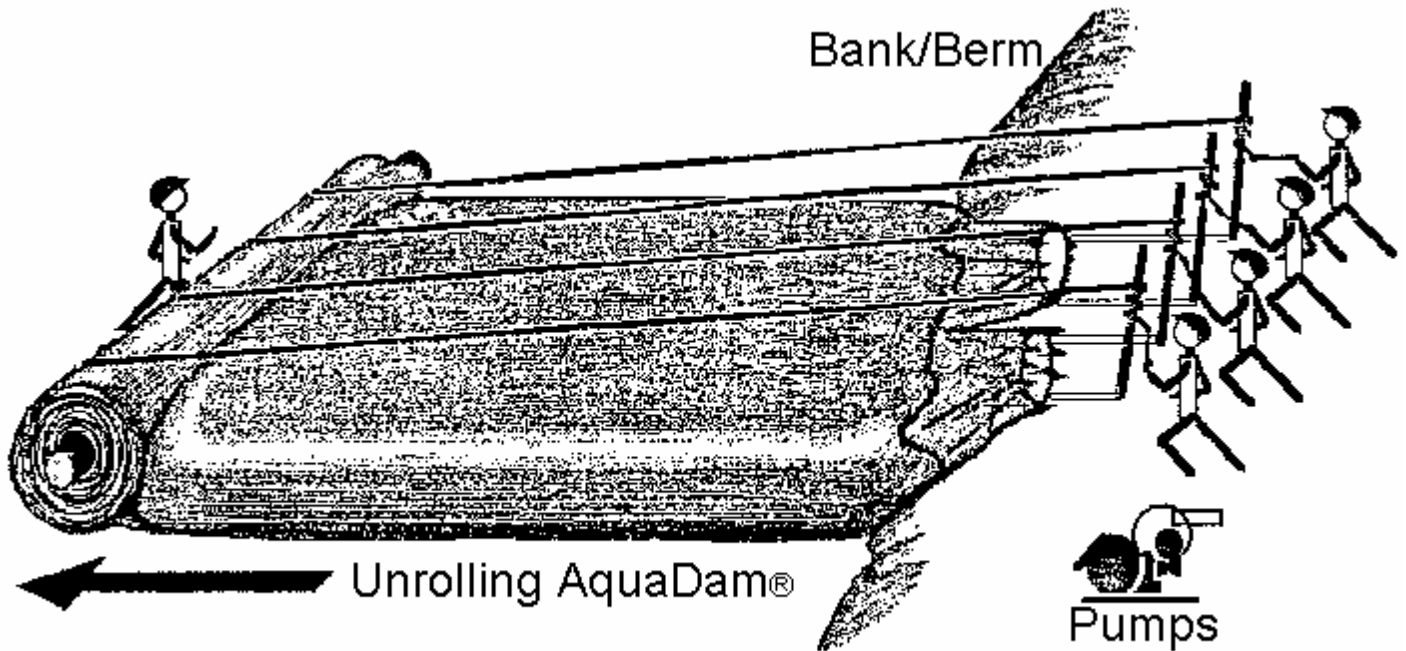

Figure 3. shows the location of the ropes, posts, laborers and the inflating AquaDam®.

Step 7-Inflating the AquaDam®:

Figure 3 represents the most difficult installation scenario, such as a flowing stream where ropes must be used. The onsite conditions can change quickly in live streams because water depths will change from one side of the AquaDam® to the other. This difference in pressure will make the AquaDam® move downstream unless head pressure is maintained inside the AquaDam® during all phases of the installation. An AquaDam® that is unrolled too quickly and is not allowed to inflate above the level of the surrounding water will move downstream with the water flow. The workers on the bank slowly let the ropes out to allow the AquaDam® to unroll when inside water pressure and mass are achieved. Unroll 2-3 feet at a time, then wait for head pressure to build again, repeating this process until the AquaDam® is fully unrolled (see the Eagle River installation in Vail, CO on our website). Timing is everything. **Do not get in a hurry! Let your pumps work!** A requirement of using ropes is that the AquaDam® must be installed in a straight line. Head pressure must be maintained inside the AquaDam® to prevent it from moving. Ropes tend to move to the outside of the unrolling AquaDam®. The worker at the end of the unrolling AquaDam® adjusts the ropes and keeps them in the center by slackening and moving one rope at a time while the other ropes maintain the necessary inside pressure to keep the AquaDam® from moving downstream. On site rock that needs to be moved to assure a good seal should always be moved to the downstream side and used for support.

Figure 4:

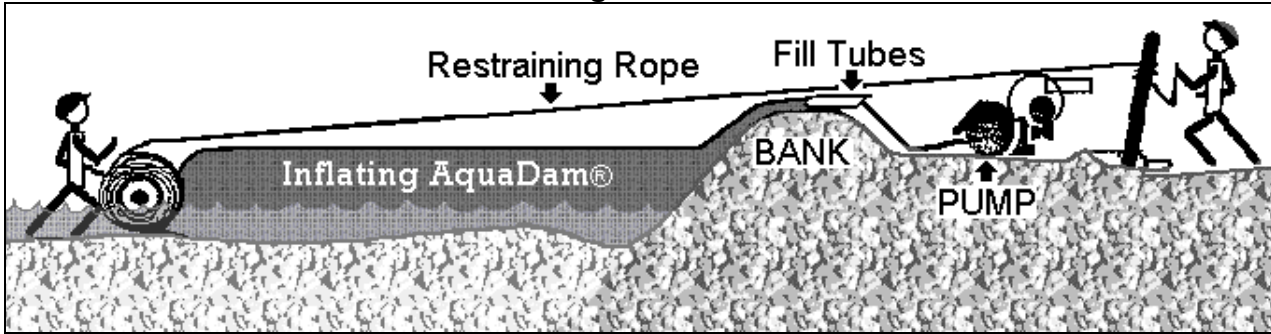

Figure 4. A cross section of a large AquaDam® being installed in flowing water, illustrating the location of the berm, pumps, ropes, laborers and the inside water head pressure, compared to the outside water levels.

Manning the Ropes:

Once the ropes are manned, the pumps are primed, and the AquaDam® is aimed in the proper direction (at a right angle to the starting point on the bank), the pumps can be turned on and the inflation process can begin. Figure 5 shows a picture of restraining ropes used during installation of a large AquaDam® in a fast moving river. The small diversion channel in this project demands that a large AquaDam® be used despite the low water level, because of the anticipated increase in water depth (above 6 feet). The AquaDam® should be unrolled at a rate of about 1 to 3 feet every time the ropes are slipped and maintain a 12-24 inch (or greater) head of water pressure inside the AquaDam®, compared to the upstream water depth, which will be increasing. Each foot of installed AquaDam® requires 2 feet of additional rope. The AquaDam® has to overcome imbalances of water head displacements happening in the river during the installation process. **Only experienced installation personnel should attempt to install large AquaDams® in moving water.** Smaller AquaDams® can be installed more easily and require less expertise.

Figure 5: USING ROPES TO INSTALL AN AQUADAM® IN FLOWING WATER



Figure 5.: A large AquaDam® being installed on the Saddle River in northeastern New Jersey. Only one laborer is needed in the water to keep the ropes in position. Using ropes require that the AquaDam® only be installed in a straight line. Connections can be made at a later date if turns are required. Coupling collars are placed underneath the first AquaDam® as it is being unrolled(if connections are necessary).

Lateral Movement:



An AquaDam® being installed in flowing water can be vulnerable to moving downstream during the installation process. Maintaining internal head pressure is very important. To give support along the side of the AquaDam® a small mound of fill material can be placed directly downstream so that the AquaDam® rests against it. A small mound every 20-30 feet provides a tremendous amount of support. Of course, turbidity is kept to a minimum because the flow has already been diverted by the AquaDam® as it is being installed.

Another technique used to install large AquaDams® in flowing water is to install a shorter, sometimes smaller dam in a straight line using ropes (this is sometimes referred to as a “buffer”), and then place the bigger AquaDam® directly upstream, allowing it to rest against the smaller AquaDam®. In this fashion, the pressure in the larger upstream AquaDam® can be lowered to allow it to turn around the end of the smaller AquaDam®, without it having to be kept in a straight line with ropes. You can see an example of this on the Williams Transco Gas Pipeline project in McComb, MS on our website.

How Lateral Movement Occurs:

Lateral movement of an AquaDam® during installation occurs when there is insufficient water mass inside the AquaDam® to overcome the difference in water pressure on the upstream side of the AquaDam® (compared to the downstream side, which will always be less). The difference in water depth must be compensated for by the amount of pressure inside the AquaDam® during and after installation. Water levels will rise rapidly during installation and should be monitored continuously by the crew in the water.

Sometimes lateral movement is hard to detect, but usually the following are indications:

-  Visual lateral movement of the AquaDam®.
-  The seams on the AquaDam® are straight for some distance but appear bent in the middle.
-  The AquaDam® is no longer pointed in the direction originally taken.

If lateral movement begins to take place or evidence of rolling can be detected, then steps should be taken to correct it. A 6-12 inch change in water level could wipe out all of the installed AquaDams® if the proper amount of head pressure is not kept inside. One step that can be taken to prevent lateral movement is to increase the internal water volume that creates the internal pressure. Fill material can be placed directly on the downstream side in small amounts, allowing the AquaDam® to rest on it. All rocks moved for seepage control should be used to shore it up during installation. Often, fill material has to be excavated from the channel. This is placed behind the AquaDam® for storage, and allows the AquaDam® to rest on it so that more water depth can be controlled than what our User's Guide suggests.

AquaDams® should always be filled with the maximum amount of water possible. Always fill your AquaDams® to their recommended height.

Other solutions to moving or sliding are to install a smaller AquaDam® directly behind the main AquaDam® on the dewatered side. In standing water, stop dewatering and allow the bodies of water on either side of the AquaDam® to equalize.



Figure 6: SHORING-UP CROSS SECTION

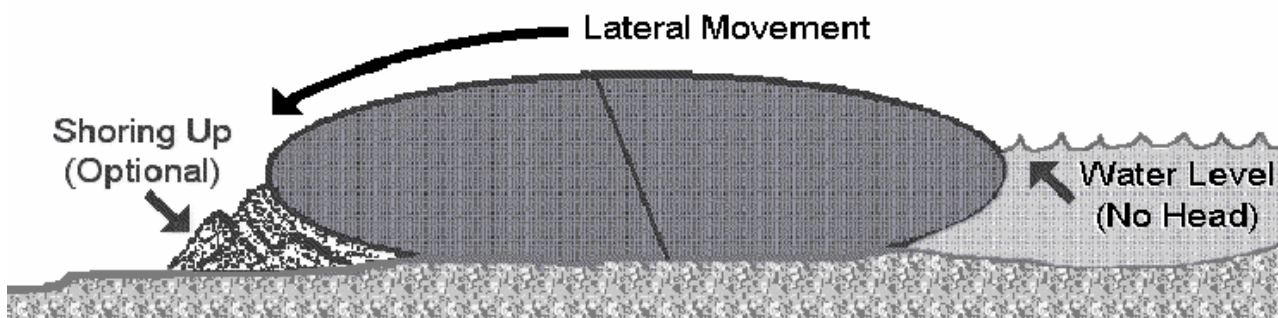

Figure 6. A cross section showing the placement of earthen fill material to shore up an AquaDam® that shows signs of lateral movement.

CONNECTING AQUADAM® SECTIONS USING COUPLING COLLARS:

Step 1: Certain applications require two or more sections to be coupled together to form a longer, continuous water-filled cofferdam. The following illustrates how this is accomplished (the procedure assumes that the AquaDams® are being joined in a straight line end to end). All standard closed-ended AquaDams® come with a coupling collar on the closed end. The other end has the fill tubes, and has been designed to fit snugly into the coupling collar. Before a second AquaDam® can be attached, step one is to install an AquaDam® fitted with a coupling collar.



Step 2: Position the second AquaDam® directly behind and in-line with the filled AquaDam® and unroll about 10 feet of the new section, plus the length of the fill tubes (see Figure 7a).



Step 3: Gather up the end of one fill tube, gently twist or bunch it up, and wrap with duct tape. Do the same thing to the other tube. This will allow the inner tubes to be easily inserted and pulled through the round holes cut into the top of the coupling collar at the end of the installed AquaDam® (see Figure 7b)



Step 4: Carefully cut two round holes 6 inches in diameter in the top of the collar attached to the filled AquaDam® master tube. Each hole should be large enough to accommodate the bunched inner fill tube of the AquaDam® that is being attached. The two holes should be positioned midway between each side of the AquaDam®. They should be about 1-2 feet apart on a four foot AquaDam® and 4 feet apart on a six foot high AquaDam®.



Step 5: Insert the wrapped right inner tube through the hole on the right side of the coupling collar, and the wrapped left inner tube through the hole on the left side of the coupling collar. This is done by working your way inside the coupling collar, pushing the inner tube toward the hole and having a second person reach through the hole from the outside, grab the tube, and pull it through the hole (about four feet of fill tube should be pulled on top for a four foot high AquaDam®). Pull the outer tube of the AquaDam® being connected inside the coupling collar and around the inner tubes as well as possible. The new section should be totally enclosed by the coupling collar, and the master tube of the AquaDam® being installed should be pulled up so as to be in contact with the end of the water-filled AquaDam®. Pull all excess fill tube material up on top through the holes.

(see Figure 7c).



Step 6: The 4'X8'X ½" sheet of plywood described in the equipment list is for the pumps to sit on, should they need to be placed on an inflated AquaDam®. When two AquaDams® are coupled or attached together, pumps are generally set on the previously filled AquaDam®, about 15-20 feet away from the end of the AquaDam®. The plywood will prevent damage to the AquaDam®, but it is not necessary by any means.



Step 7: Remove the tape or string from around the bunched inner fill tubes and insert the discharge hoses deep inside them, making sure that they extend past the coupling collar. Removal of fittings on the discharge hoses is recommended. If they cannot be removed, cover metal ones with duct tape. To keep the fill hoses from sliding back out, bunch the fill tubes up around them and secure with duct tape



(see Figure 7d).

Step 8: At this point the new section is ready to be filled in the same manner as the first section. Follow all of the instructions previously presented to install the first AquaDam®. Figure 8 is a drawing of two AquaDams®, one filled and the other ready to be filled.



Figure 7: CONNECTING AQUADAMS® USING COUPLING COLLARS

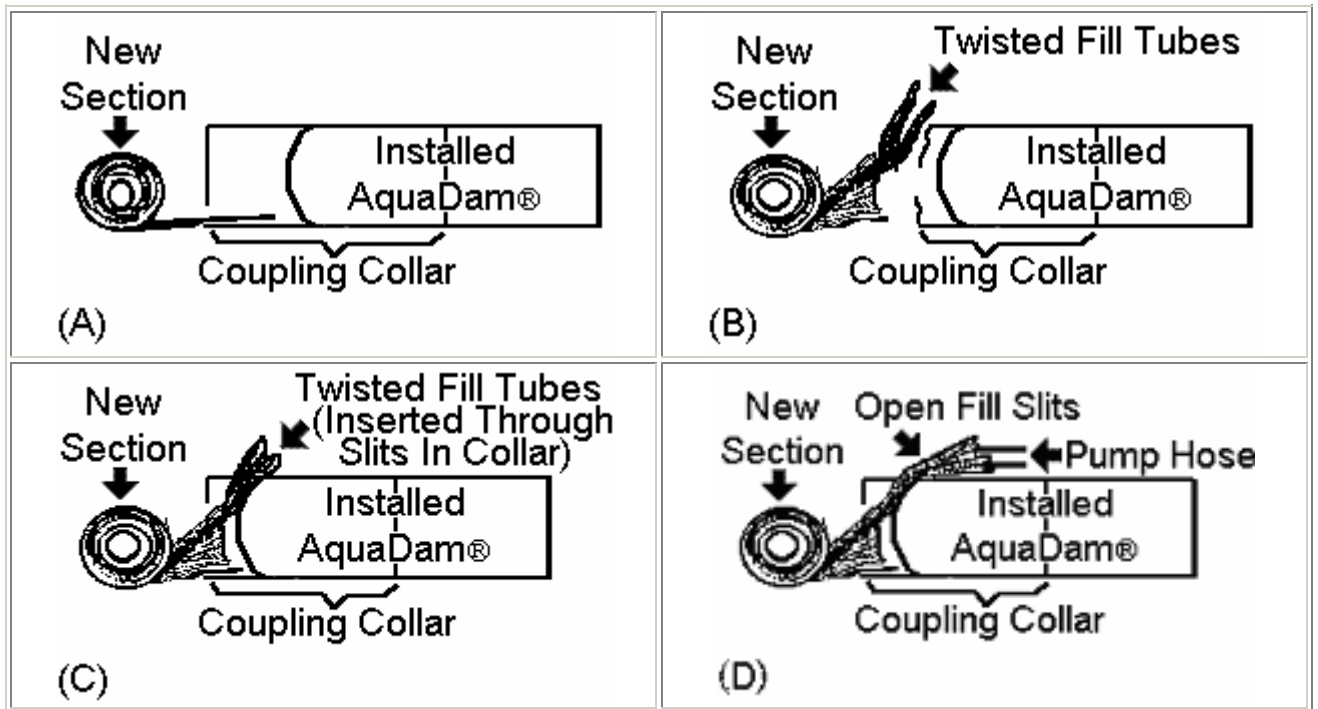

Figure 7, illustrations a, b, c, and d show the different steps taken in the process of joining two AquaDams® together using a collar.

Figure 8: TWO AQUADAMS® COUPLED TOGETHER:

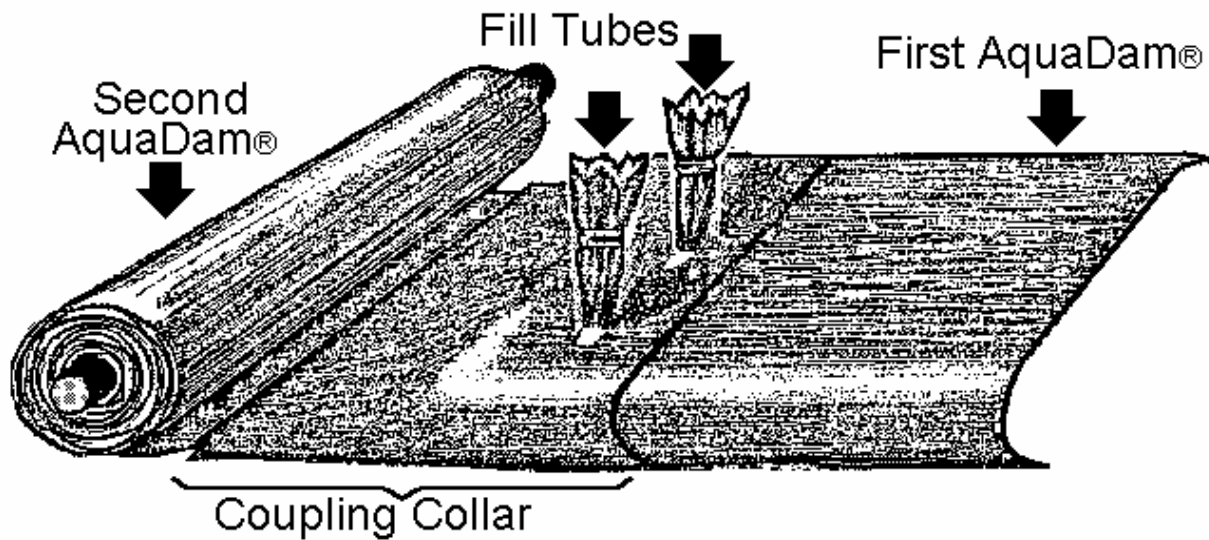

Figure 8: Two AquaDams® are joined together by a coupling collar and ready to be inflated. The two inner tubes stick out and up from the middle portion of the coupling collar. These are the extra fill tubes located at the open end of each AquaDam®.

Step 9: When the second section is filled, the water hoses can be removed from the inner tubes. The fill tubes are rewrapped with duct tape tightly and in such a manner that the tubes will stand up by themselves (see the Woodlawn Lake Sediment Removal project in San Antonio, TX on our website). If possible, use duct tape to attach the two upright inner tubes together, making them even more stable and preventing water from leaking out. Gravity will keep the water from rising above the height of the fill tubes.

MAINTENANCE PROCEDURES

Installed AquaDams® are durable and will last a long time. Each installed section should be monitored regularly for leaks. The easiest way to deal with a leak without removing the AquaDam® is to pump more water into it. Small leaks can be patched with special repair tape

There are four important observations that should be made on a regular basis.

- 🌊 Leaks in the AquaDams®
- 🌊 Seepage under the AquaDams®
- 🌊 Inner fill tubes that have fallen over and are draining water
- 🌊 Lateral movement of the AquaDam®



Most leaks are of such a nature that they can be resolved simply by pumping additional water into the AquaDams® on a periodic basis. Identify which of the tubes is leaking, untie and unwrap the inner tube and insert the discharge hose from the water pump and fill it. Sometimes, a leak is large enough to require a patch. To repair such a leak, first identify and isolate the area around it. Then, using a sharp knife, cut a 'cross' or X through the master tube and pull the material apart to expose the leak, being careful not to further damage the inner tube. Then, using tape provided by AquaDam Inc , apply the patch to the inner tube. Once the leak is repaired, cover the 'cross' cut in the master tube with the same repair tape. In most cases it is best to just add water on a regular basis, until the AquaDam® can be taken out of service and patched properly from the inside or the inner tubes can be replaced.

AQUADAM® REMOVAL USING REROLLING BRACKETS

Rerolling a small AquaDam® after use in a small stream. When two or more AquaDams® are connected together the downstream AquaDam® is removed first by pumping out the inside water, or allowing the fill tubes to drain the AquaDam® down to a level where the connection can be disassembled, allowing the water to pass out freely once rewinding begins at the other end. This forces the water to the open end and out.

Note: in some cases, it may be a better idea to hook the closed end to an excavator or other piece of equipment, lift it up, and simply let gravity drain the water out (see below).



LARGE AQUADAM® REMOVAL

For larger AquaDams® that are too big to reroll in place, equipment such as an excavator or backhoe can be used to pull the AquaDam® from the lake (in standing water). Pump out or drain as much of the water as you can, and put a strap around the closed end of the AquaDam®. Place the strap as close to the end as possible or water will remain trapped inside. **Do not pull on the collar.** Very slowly lift up on the strap. The water should drain out the open end. Make sure that the fill tubes are draining, they might need to be pulled further off the bank. Go slowly so that you do not lift the water any higher than is necessary for it to drain. Pull the deflated AquaDam® out of the water. It can now be blown up with air for inspection and rerolling. After the AquaDam® has been inspected and any holes have been patched, make sure that the coupling collar is still in place. It is now time to reroll the AquaDam® for storage and reuse. AquaDams® can be reused over and over again, depending on the application. They can also be used on a one-time basis and be destroyed when they are removed, or if they become contaminated with a hazardous material. It is difficult to remove large AquaDams® used to block off flowing streams and rivers. Sometimes, there is no way to remove the AquaDam® and maintain the internal water pressure necessary to hold it in place at the same time.



As the AquaDam® is being emptied, it will be forced out of the way by the difference in water depth from the upstream side of the AquaDam® to the downstream side.

There are many applications where an AquaDam® can be saved and rerolled for use at a later date. All smaller AquaDams® can be rerolled. Rerolling requires brackets to fit over the ends of the wooden beams that the AquaDams® come assembled on. A 3/4" drive ratchet can then be attached to the bracket. A 5' long section of pipe is slid over the handle of the ratchet (a cheater bar) to achieve maximum torque. Water can be pushed to the open end and out.

SAFETY

Emergency Removal:

Laborers should stay out of harm's way and be aware that standing at the end of the unrolling AquaDam® is dangerous, and they should stand clear whenever possible. The number of personnel in this position should be kept to a minimum. Should the laborers holding the ropes let go of them, the AquaDam® will rapidly unroll, and a laborer could be pinned underneath. That is why **all laborers should carry safety knives**, so that the AquaDam® can be slit open on the upstream side to relieve inside water pressure so that the AquaDam® will immediately drain, allowing it to move off of the trapped worker. The best way to do this is with a single long, lateral slice down the side of the AquaDam®. You must be standing on the upstream side. The downstream side is the direction that the AquaDam® and all of the water behind it will move in. It is very important that everyone works together!

Obstacles & Debris:

The beds of rivers and streams are rough and can have holes and other obstacles that should be avoided in them. The easiest way to avoid them is to just go around. Removing something large that is silted into the riverbed will leave a large hole. This leaves you worse off than you were before. Going over this type of area will have more seepage, and it will also affect the height of the AquaDam®.

Cold Weather:

In cold water, neoprene chest waders are highly recommended. All OSHA rules and guidelines should be followed closely. Personal Flotation Devices (PFDs) should be also used.

Walking on the AquaDam®

The woven geo-textile fabric that the master tube is made of is puncture and UVI resistant. Heavy foot traffic on top of the AquaDam® is okay. The only time you might curtail foot traffic is during cold weather, when ice occurs within the inner tubes, but they can still be walked on. The ice may cut the polyethylene when it cracks or breaks from foot traffic.

AquaDam Specifications

Dimensions (completely full)	Controllable Mud/Water Depth	Specifications of Inner and Outer Tubes	Capacity in Gallons (gal per ft.)	Empty Weight (lbs per ft.)
1' H x 2' W* (0.3m high)	9" (23 cm)	Same material thickness and strength as 4' high AquaDam	12	0.75 lbs
1.5' H x 3' W* (0.5m high)	14" (36 cm)	Same material thickness and strength as 4' high AquaDam	25	0.95 lbs
2.5' H x 5' W* (0.76m high)	24" (61 cm)	Same material thickness and strength as 4' high AquaDam	88	1.85 lbs
3' H x 7' W (1m high)	30" (77 cm)	Same material thickness and strength as 4' high AquaDam	120	2.5 lbs
4' H x 9' W (1.2m high)	38" (97 cm)	12 mil polyethylene inside tube. 300 lb/in ² burst strength woven polyethylene geotextile outside tube.	240	4.25 lbs
5' H x 11' W (1.5m high)	44" (112 cm)	Same material thickness and strength as a 8' high AquaDam	320	6.4 lbs
6' H x 13' W (1.8m high)	54" (137 cm)	Same material thickness and strength as a 8' high AquaDam	400	8.5 lbs
8' H x 17' W (2.4m high)	74" (188 cm)	12 mil polyethylene inside tube. 2 plys of 300 lb/in ² burst strength woven polyethylene geotextile outside tube.	500	12 lbs
10' H x 21' W (3m high)	90" (229 cm)	8 mil polyethylene inside tube. 3 plys of 300 lb/in ² burst strength woven polyethylene geotextile outside tube.	800	25 lbs
12' H x 25' W (3.7m high)	104" (264 cm)	2 plys of 8 mil polyethylene inside tube 1 ply shroud surrounding inside tubes 4 plys of 300 lb/in ² burst strength woven polyethylene geotextile outside tube.	900	31 lbs
16' H x 33' W (4.8m high)	132" (335 cm)	2 plys of 5 mil polyethylene inside tube 1 ply shroud surrounding inside tubes 5 plys of 300 lb/in ² burst strength woven polyethylene geotextile outside tube.	1250	45 lbs

All AquaDams 3' and taller are manufactured with an internal baffle for added stability. Smaller AquaDams can be special ordered with a baffle. Call for pricing.

Aqua Dam Inc
 "Water Controlling Water"
www.aquadam.net
 1.800.682.9283
 +1.707.764.1999
 matthew@aquadam.net